

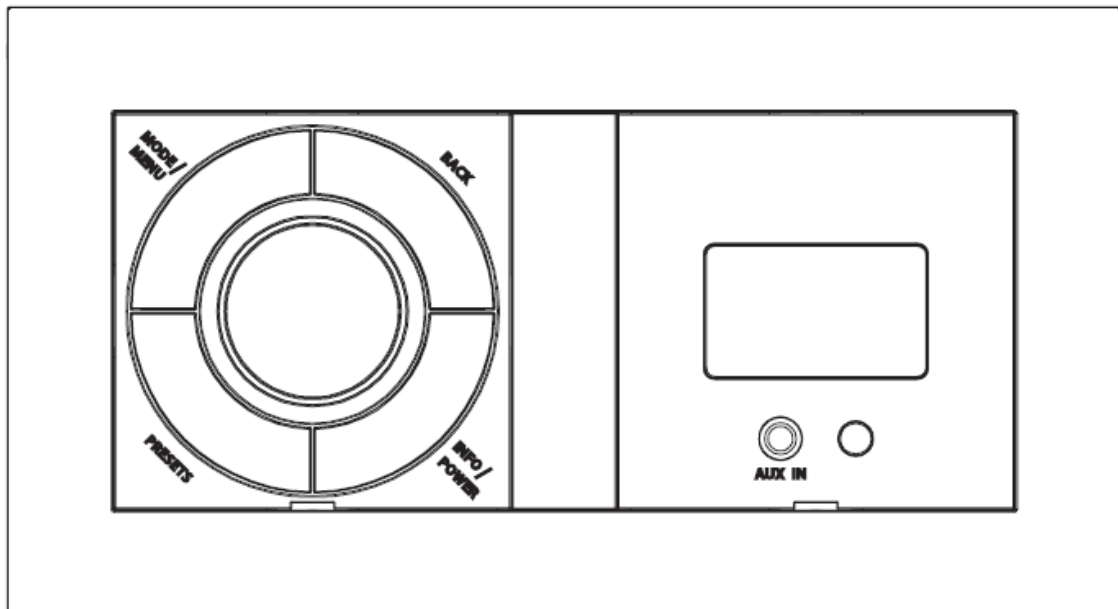

I n t e r n e t , D A B / D A B + a n d F M R a d i o

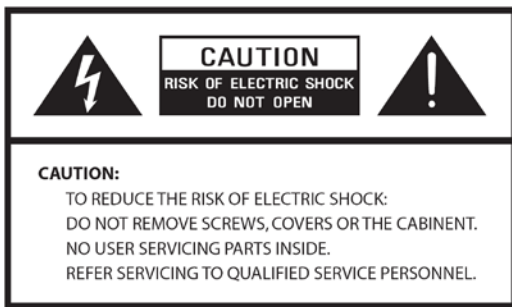

Safety Information



The lightning flash with arrowhead symbol within an equilateral triangle is intended to alert the user to the presence of uninsulated "dangerous voltage" within the product's enclosure that may be of sufficient magnitude to constitute a risk of electric shock to persons.



The exclamation point within an equilateral triangle is intended to alert the user to the presence of important operating and maintenance (servicing) instructions in the literature accompanying the appliance.

WARNING: TO REDUCE THE RISK OF FIRE OR ELECTRIC SHOCK, DO NOT EXPOSE THIS APPLIANCE TO RAIN OR MOISTURE.

IMPORTANT SAFETY INSTRUCTIONS

To reduce the risk of electrical shock, fire, etc.:

1. Read these instructions.
2. Keep these Instructions.
3. Heed all Warnings.
4. Follow all instructions.
5. Do not use this apparatus near water.
6. Clean only with dry cloth. For stubborn stains, use a soft cloth dampened with a weak solution of mild detergent and water. Dry the apparatus immediately afterwards with a clean cloth. Do not use abrasive clothes, thinners, alcohol, or other chemical solvents, because they may damage the finish or remove the panel lettering.
7. Do not block any ventilation openings. The ventilation shall not be impeded by covering the ventilation openings with items, such as newspapers, table clothes, curtains, etc.
8. Do not install near any heat source such as radiators, heat registers, stoves, or other apparatus (including amplifiers) that produce heat.

9. Do not defeat the safety purpose of the polarized or grounding - type plug. A polarized plug has two blades with one wider than the other. A grounding type plug has two blades and a third grounding prong. The wide blade or the third prong are provided for your safety. If the provided plug does not fit into your outlet, consult an electrician for replacement of the obsolete outlet.

10. Protect the power cord from being walked on or pinched particularly at plugs, convenience receptacles, and the point where they exit from the apparatus. If the power cord is damaged, it must be repaired by a qualified repairer.

11. Only use attachments/accessories specified by the manufacturer.

12. Use only with the cart, stand, tripod, bracket or table specified by the manufacturer, or sold with the apparatus. When a cart is used, use caution when moving the cart/apparatus combination to avoid injury from tip-over.



PORTABLE CART WARNING

13. Unplug this apparatus during lightning storms or when unused for long periods of time.

14. Refer all servicing to qualified service personnel. Servicing is required when the apparatus has been damaged in any way, such as power-supply cord or plug is damaged, liquid has been spilled or objects have fallen into the apparatus, the apparatus has been exposed to rain or moisture, does not operate normally, or has been dropped.

15. The apparatus shall not be exposed to dripping or splashing and no objects filled with liquids, such as vases, shall be placed on the apparatus.

16. The mains plug or an appliance coupler is used as the disconnect device, the disconnect device shall remain readily operable.

17. Please read Rating Labels at the back of the unit for power input and other safety information.

Contents

Safety Information.....	2
Contents.....	3
Package Contents.....	5
Unit Overview.....	5
Remote Control overview.....	6
Internet Radio Quick Start Guide.....	7
What you need before you can use your Internet Radio.....	7
Chapter 1 Internet Radio Mode.....	8
1.1 Turning on.....	8
1.2 Setup Wizard.....	8
1.3 Access to Wireless Network.....	9
1.4 Local Stations.....	9
1.5 Choose a Station.....	10
1.6 Select a Station through Podcasts.....	10
1.7 Get Access Code and FAQ Solutions.....	10
1.8 Add Station to ‘My Favourites’.....	11
1.9 Add Station to ‘My Added Stations’.....	12
1.10 Connecting to Wired Network.....	13
1.11 Shift to Wireless Network.....	13
Chapter 2 Music Player Mode.....	14
Chapter 3 DAB Mode.....	16
3.1 Getting Started.....	16
3.2 Shift to another DAB/DAB+ Station.....	16
3.3 Update Station List.....	16
3.4 Dynamic Label Segment (DLS).....	16
3.5 Prune Invalid.....	16
3.6 DRC (Dynamic Range Control) Value.....	17
3.7 To change station order.....	17
Chapter 4 FM Mode.....	18
4.1 General Operation.....	18
4.2 Scan Setting.....	18
4.3 Audio Setting.....	18
4.4 Station Presets (for Internet, DAB and FM Mode).....	19
4.5 Access Preset Station (for Internet, DAB and FM Mode).....	19
Chapter 5 AUX IN Mode.....	20
Chapter 6 General Settings.....	21
6.1 Sleep Function.....	21
6.2 Setting Clock.....	21
6.3 Browse Station Information.....	21
6.4 Setting Alarm.....	22

6.5	Equaliser	23
6.6	Language.....	23
6.7	Factory Reset	23
6.8	Enter Setup Wizard	23
6.9	SW Version and Radio ID (or System Info).....	23
6.10	Network Setup	24
6.11	Software Update.....	24
6.12	Backlight.....	24
Chapter 7	Specification	25
Chapter 8	Troubleshooting	26

Package Contents

Carefully unpack and remove the package. You will find:

- User guide
- Main unit
- User manual

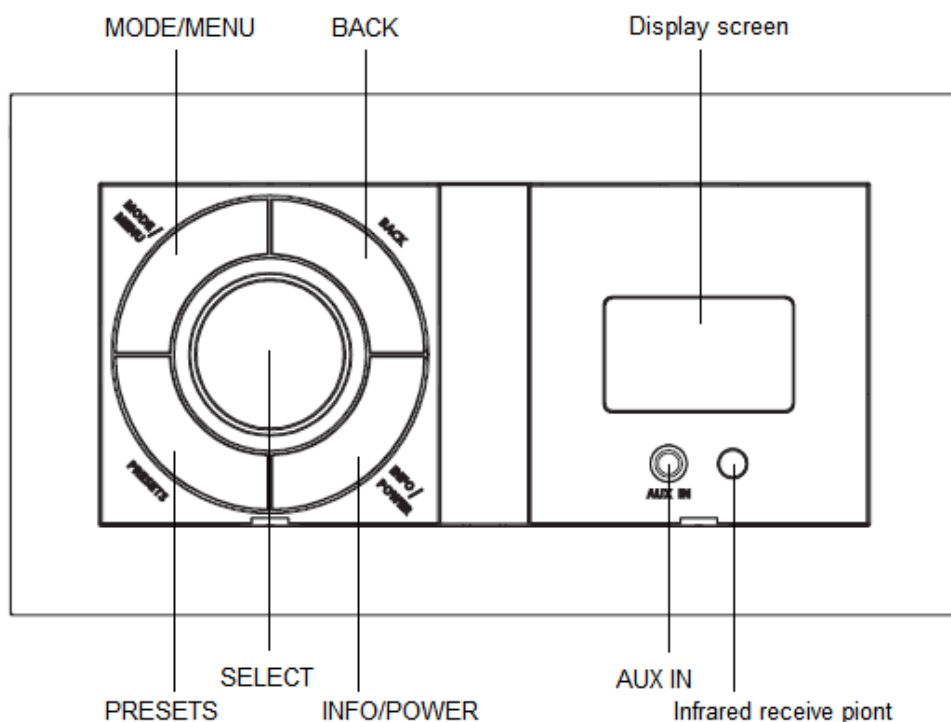

Unit Overview

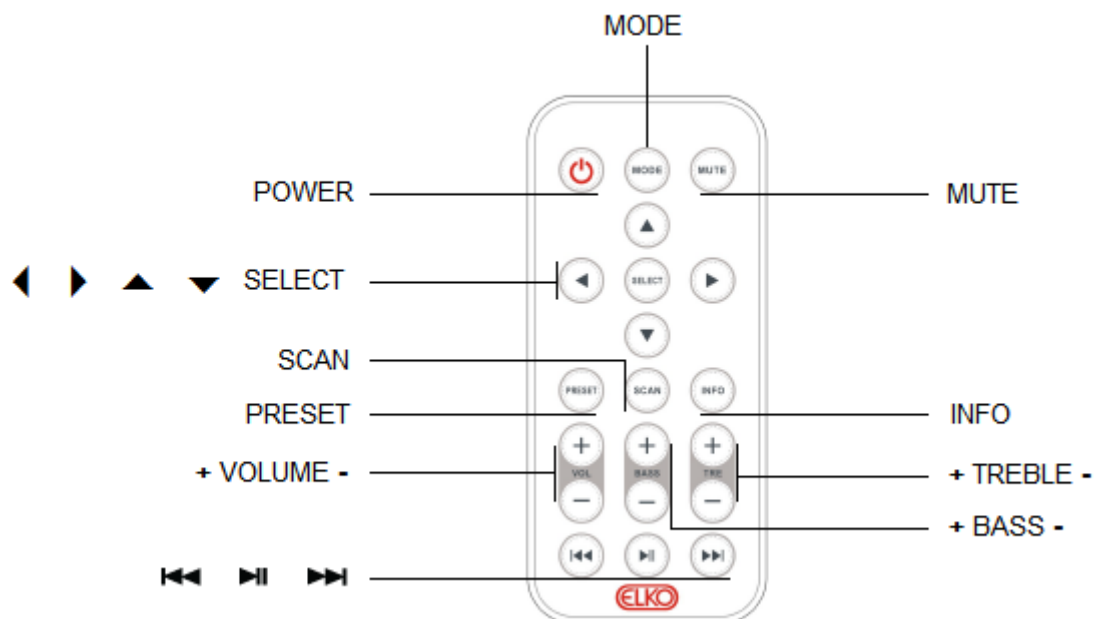

Keys	All mode
INFO/POWER	a. Long press to turn on/off Radio. b. When alarm is sounding, long press to turn off alarm. c. Internet, Media Player, DAB/DAB+ and FM mode: Press to browse station info.
MODE/MENU	Press to change mode. Long press to go to 'main menu' and other options.
BACK	Press to go to previous page.
PRESETS	Internet, DAB/DAB+ and FM mode: Press and hold to activate preset stations function; and short press to load preset stations.
SELECT	a. In Menu , turn to browse options, press to confirm. b. While a program is playing, turn to adjust volume level. c. FM mode: while frequency is showing up, press and turn it to manually adjust frequency 0.05MHz per step, or long press to autoscan active stations. d. When alarm is sounding, press to activate Snooze function.

Remote Control overview



Control	All mode
	Press to turn on/off radio.
	Press ◀ or ▶ to scroll right and left. Press ▲ or ▼ to scroll up and down. Press SELECT to confirm.
MODE	Press to change mode.
MUTE	Press to put radio into mute mode, press again to exit this order.
PRESET	Internet, DAB/DAB+ and FM mode: Press and hold to activate preset stations function; and short press to recall preset stations.
SCAN	DAB/DAB+, FM mode: Press to autoscans active stations.
INFO	Internet, Music Player, DAB/DAB+ and FM mode: Press to browse station information.
+ VOLUME -	Press to adjust volume level.
+ BASS -	Press to adjust bass value.
+ TREBLE -	Press to adjust treble value.
	Music player mode: Press ◀◀ to previous track, press ▶▶ to next track, play ▶ to play/pause.

Internet Radio Quick Start Guide

What you need before you can use your Internet Radio

Thanks for your buying! Before use it, you need to know followings:

Wireless LAN Setting:

- A broadband Internet connection.
- A wireless access point (Wi-Fi) connected to your broadband Internet, preferably via a router.
- If your wireless network is configured to use Wired Equivalent Privacy (WEP) or Wi-Fi Protected Access (WPA) data encryption then you need to know the WEP or WPA code so you can get the Internet Radio to communicate with the network.
- For security reason, you may need enter the Radio's MAC address into your wireless access point. To find the Radio's MAC address, use menu items as follows:

Main menu → System settings → Network → View settings → MAC Address

- To enter the MAC address into your wireless access point, you must read the instructions supplied by the wireless access point.

Before you continue, make sure that your wireless access point is powered up and connected to your broadband Internet. To get this part of the system work, read the instructions supplied by the wireless access point is highly recommending!

Chapter 1 Internet Radio Mode

1.1 Turning on

Long press **INFO/POWER** to switch on radio, for initial use, 'Setup wizard' is requested.

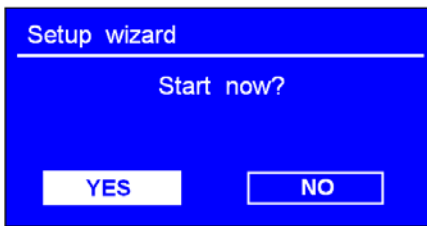

1.2 Setup Wizard

1. Continue the above step, press **SELECT** to confirm 'YES' → turn **SELECT** to your preferred 'hour format', press **SELECT** to confirm.

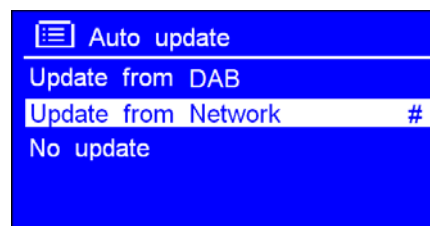
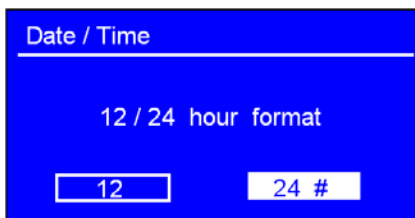

2. Press **SELECT** to confirm 'Update from Network'. Now, follow your radio's instruction, configure the following parameters:

- Timezone:** select your local timezone.
- Daylight savings:** On or Off
- Wlan region:** Most of Europe/USA/Canada/Spain etc.
- SSID:** Sometimes radio may find more than one network, turn **SELECT** to your selecting one, then press **SELECT**.

Note: If a password (WEP/WPA) isn't required by your network, radio will connect to the network automatically.

3. If a WEP/WPA key (password) is required, radio will ask you to input the WEP/WPA code and display the password entry screen as:



- Turn **SELECT** to cycle through the alphanumeric character list, press **SELECT** to select an appointed character.

Note: WEP/WPA pass codes are case-sensitive.

- If a wrong operation is being conducted, select '**BKSP**' to delete this wrong character.



Note: a.> **BKSP** = Backspace.

b.> the method of select **BKSP**, **OK** or **CANCEL**: while cursor point to '0', anti-clockwise turn **SELECT** to select **CANCEL**, then continue anti-clockwise turn **SELECT** to select **OK** or **BKSP** in turn.

c.> **CANCEL** means back to previous track.

d.> Radio will automatically save the WEP/WPA you've input, so no bother to re-enter these codes.

- After select the final character of your password, turn **SELECT** to **OK** →press **SELECT** to confirm.

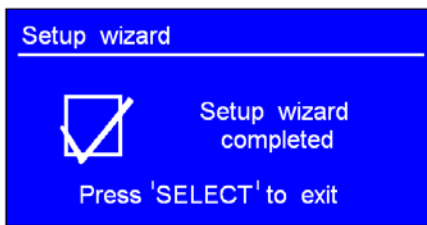

- Press **SELECT** again to exit, **the setting is OK now!**

1.3 Access to Wireless Network

- After set the 'setup wizard', it will show you as below, and then press **SELECT** to enter 'Internet radio' mode.

*Note: Or, you may also press **MODE/MENU** repeatedly until 'Internet radio' shows up, then stop press to enter.*

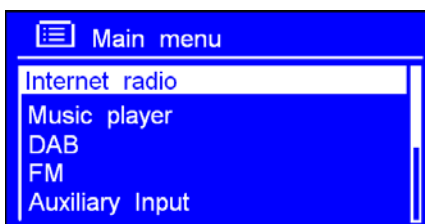

or



- While cursor point to < **Station list** >, press **SELECT** to confirm.

If it fail to connect to internet, please follow:

- Check your router, see it working normally or not;
- Relocating your radio to a stronger signal position may be necessary!
- Make sure your password is input correctly.

1.4 Local Stations

Make sure your radio connected to network.

'Local China' can be changeable according to your current location, for instance, it can be local US, local UK, etc. In a word, it's a very easy way for you to pick up local programs.

- To enter Local stations, long press **MODE/MENU** → < **Station list** > → < **Local China** >, press **SELECT** to confirm.



→



- Turn **SELECT** to your favourite item, press **SELECT** to confirm, and then step by step to the program you wanted.

1.5 Choose a Station

 **Note:** ensure your radio connecting to network.

1. To access to this order, long press **MODE/MENU** → < **Station list** > → < **Stations** >, press **SELECT** to confirm.

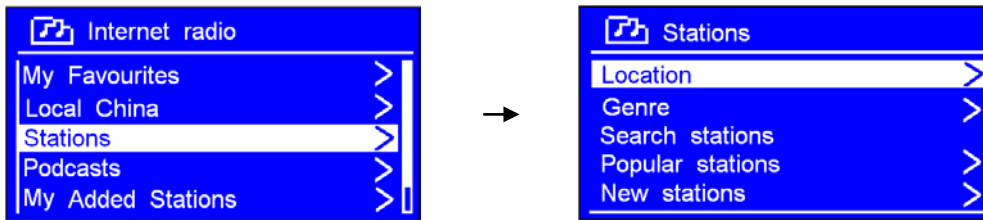

2. There are five options available for you to choose a station as above photo.

* **'LOCATION'** enables you to choose from the radio stations provided by any country which you choose from a list.

- a. While cursor point to < **Location** >, press **SELECT** to confirm.
- b. Turn **SELECT** to the region you wanted, press **SELECT** to confirm.
- c. Using the same method to choose country, station in turn, radio will perform loading.

* **'GENRE'** enables you to choose radio stations according to their content such as Classic Rock, Sport, News, etc.

 **Note:**

- a. Some radio stations do not broadcast 24 hours a day, and some stations are not always on-line.
- b. If this station has on-demand content, that is, it gives an option of listening to the old programs which have already been broadcast.

1.6 Select a Station through Podcasts

1. To access to this order, long press **MODE/MENU** → < **Station list** > → < **Podcasts** >, press **SELECT** to confirm, and then turn **SELECT** to your favorite option.

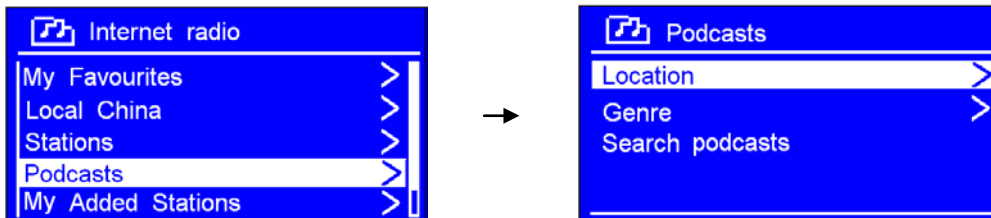

2. Press **SELECT** to confirm, and then step by step to your selecting program.

1.7 Get Access Code and FAQ Solutions

1. To access to this order, long press **MODE/MENU** → < **Station list** > → < **Help** >, press **SELECT** to confirm.

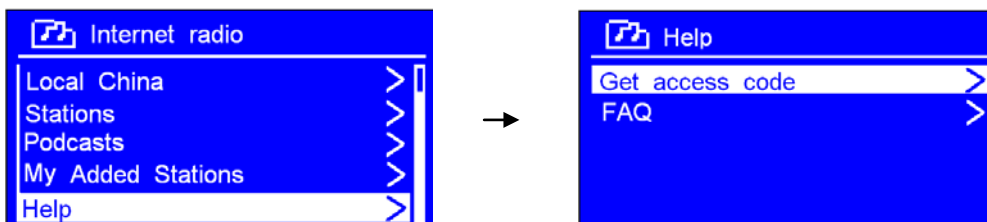

 **Note:** at this step, you can also listen radio **FAQ** solutions.

2. While cursor point to < **Get access code** >, press **SELECT** to confirm, you will get it.

1.8 Add Station to 'My Favourites'

1. Visit website: <http://www.wifiradio-frontier.com>
2. Click on the register link.



3. Create account login, **Access code** is required. How to get this code? Please refer to previous page.

Note: want to member login? Therefore save your registered '**Email address**' and '**Password**'.

4. Now, you are entitled to take advantage of the various additional features and services offered by the Frontier Internet Radio Portal.



5. After above setting is done, in order to have your radio access your new settings, get your radio power off for several minutes is necessary.

6. How to play '**My favourites**'? You need two steps:

- a. Long press **MODE/MENU** → < **Station list** > → < **My favourites** >, press **SELECT** to confirm.
- b. Turn **SELECT** to your favorite option → press **SELECT** to load.

Note: Your added '**my favourites**' stations will show up at '**my favourites**' subdirectory. Doing a 'factory reset' cannot erase them.

1.9 Add Station to 'My Added Stations'

Even though the Internet Radio portal contains thousands of stations, you may want to listen to stations not listed. You can add your own stations via the portal.

1. Visit website: <http://www.wifiradio-frontier.com>
2. Login as a member (at previous page, you registered).

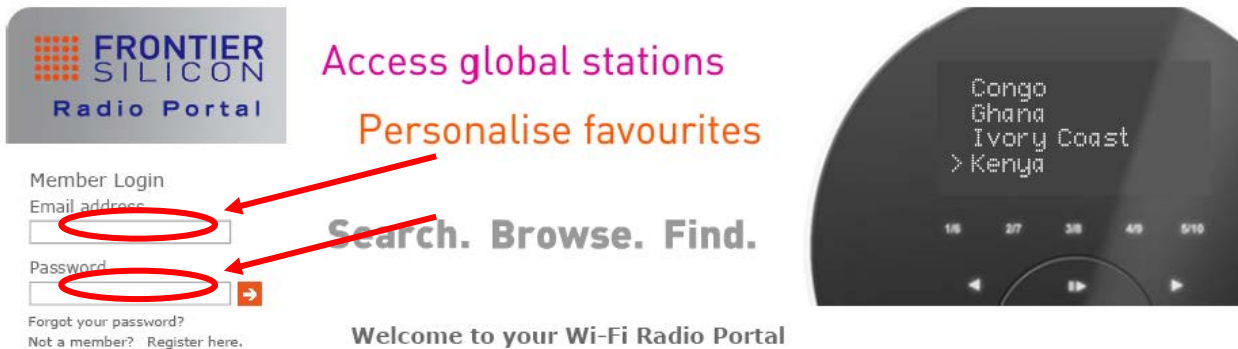

3. You will be able to take advantage of the various additional features and services offered by the Frontier Internet Radio Portal.

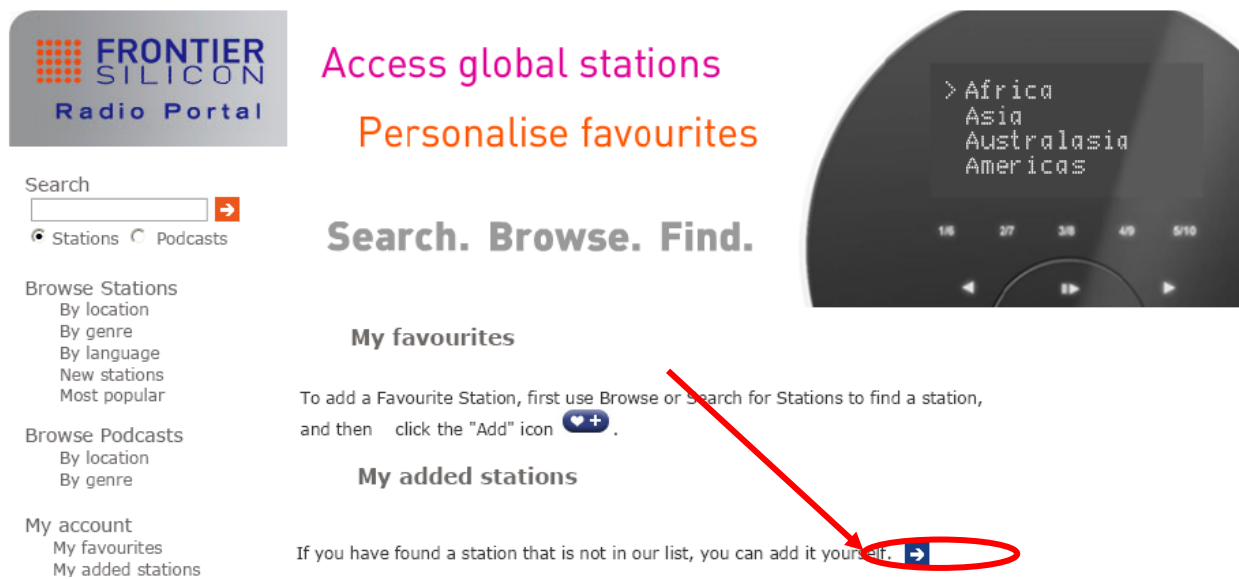

4. After above setting is done, in order to have your radio access your new settings, get your radio power off for several minutes is necessary.
5. How to play "? Your need two steps:
 - a. Long press **MODE/MENU** → < **Station list** > → < **My added stations** >, press **SELECT** to confirm.
 - b. Turn **SELECT** to your favorite option → press **SELECT** to loading...

 **Note:** Your added stations will show up at 'my added stations' subdirectory. Doing a 'factory reset' cannot erase them.

1.10 Connecting to Wired Network

Step 1 – Choose LAN Setting

 **Note:** make sure LAN cable connecting to LAN socket already.

1. Long press **MODE/MENU** → Turn **SELECT** to < **Main Menu** >, press **SELECT** to confirm.
2. Turn **SELECT** to < **Network** >, press **SELECT** to confirm.

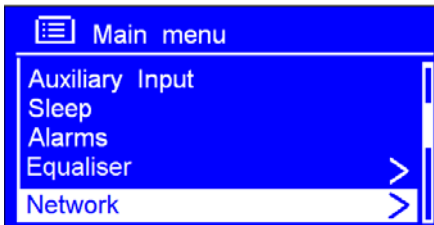

3. Turn **SELECT** to < **Manual settings** >, press **SELECT** to confirm.
4. While cursor point to < **Wired** >, press **SELECT** to confirm.
5. While cursor point to < **DHCP enable** >, press **SELECT** to confirm. **The LAN setting is OK now!**

Step 2 – Enter Internet Radio mode

1. Long press **MODE/MENU**→ 'Main menu', press **SELECT** to confirm, while cursor point to 'Internet Radio', press **SELECT** to confirm. Or, press **MODE/MENU** repeatedly until < **Internet Radio** > is showing up, stop pressing.

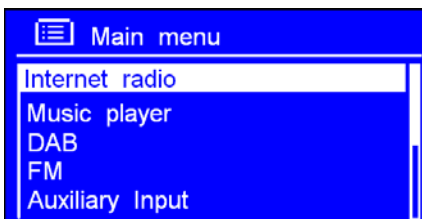

or



Step3 – Access Network

Continue the above steps, few seconds later, it will show:

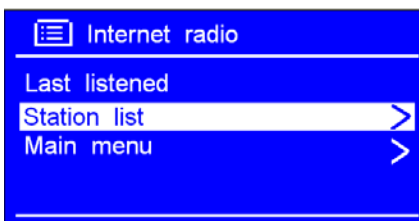

If it fail to connect to network, please follow:

- a. Check your Router, see it working normally or not.
- b. Check your LAN cable, make sure it wasn't been damaged,
- c. See the port of cable which insert to LAN socket is touching well.

1.11 Shift to Wireless Network

1. Refer to previous page 'choose LAN setting' steps 1-4, turn **SELECT** to < **Wireless** >, press **SELECT**.
2. While cursor point to < **DHCP enable** >, press **SELECT** to confirm, and then step by step to access to wireless network.

Now, wireless setting is OK!

Chapter 2 Music Player Mode

2.1 Setting up a Music Server

- In order for your radio play music files from a computer, the computer must be set up to share files or media.
- **UPnP media sharing** allows devices like this radio to play music from a shared media library, navigating through tag menus such as Artist, Album or Genre.
- If you are running a suitable server system such as a PC with Windows Media Player10 or later (WMP), and your music library is well-tagged, then it is recommended to use media sharing.
- Only the UPnP server needs to be set up.

2.2 Sharing Media with Windows Media Player

The most common UPnP server is Windows Media Player (10 or later). Alternatively, other UPnP platforms and servers may be used. To set up WMP for media sharing, perform the following steps:

1. Ensure that the PC is connected to the network.
2. Ensure that the radio is powered on and connected to the same network.
3. In WMP, add to the media library the audio files and folders you want to share with your radio (**Library > Add to Library...**).
4. In WMP, enable media sharing (**Library > Media sharing...**).

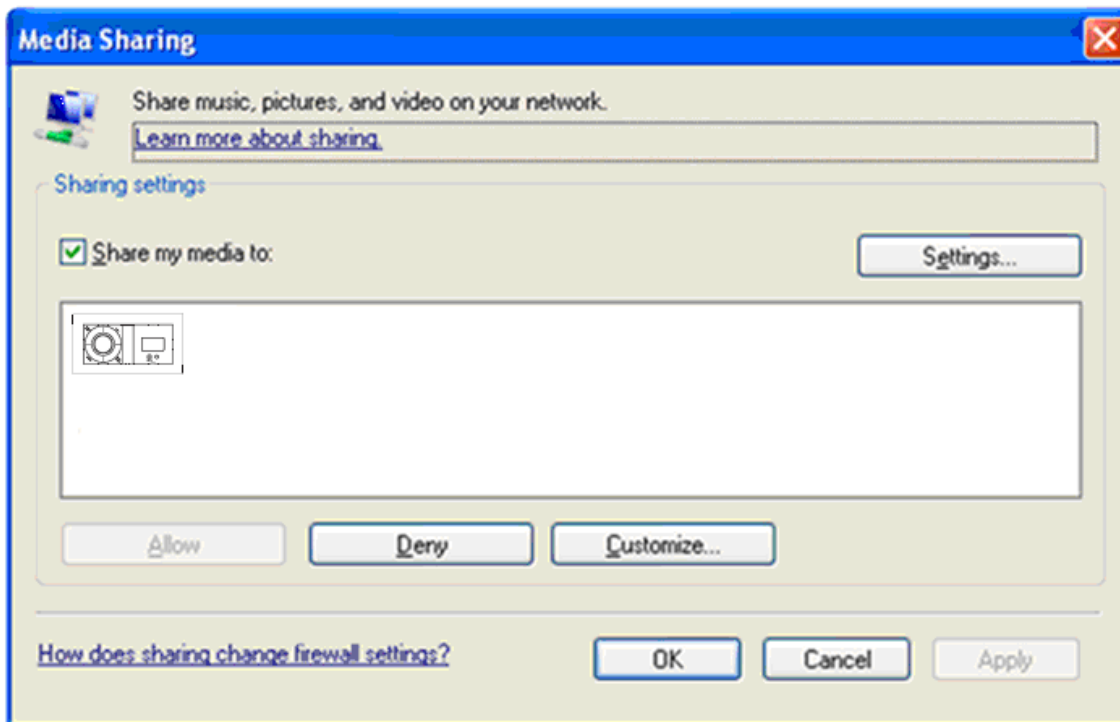

5. Make sure that the radio has access to the shared media by selecting it and clicking **Allow**. You can also set a name for the shared media in **Settings...** Click **OK** to close the dialogue boxes.
6. The PC is now ready to stream the music to the radio. The WMP UPnP service runs in the background; there is no need to start WMP explicitly.

2.3 Play Shared Media

1. Press **MODE/MENU** repeatedly until **< Music player >** is showing up.

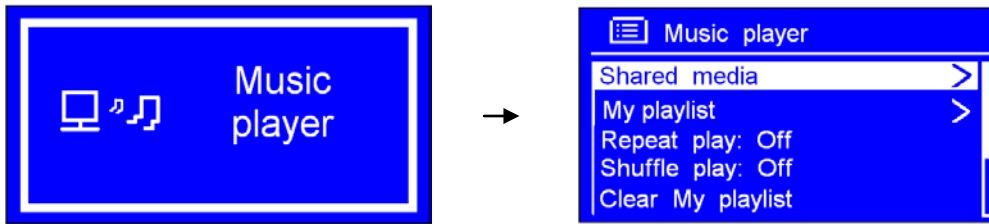

Note: Or, enter **< Main menu >**, and then turn **SELECT** to **< Music player >**, press **SELECT** to confirm.

2. While cursor point to **< Shared media >**, press **SELECT** to confirm, and then step by step to your selecting Music. Press **⏮** or **⏭** to shift tracks. Press **⏸** to play or pause.
3. Adjust the volume by turning the **SELECT** knob.

- My Playlist

It is a collection of songs added by the user from UPnP, it can be achieved by long pressing **MODE/MENU** → turn **SELECT** to **< My playlist >**, press **SELECT** to confirm.

- Repeat Play Mode

Long press **MODE/MENU** → turn **SELECT** to **< Repeat play: Off >**, press **SELECT** to shift 'Off' to 'On', or press **SELECT** again shift from 'On' to 'Off'.

- Shuffle Play Mode

Long press **MODE/MENU** → turn **SELECT** to **< Shuffle play: Off >**, press **SELECT** to shift 'Off' to 'On'.

- Clear My Playlist

Note: sometimes, you might be considered to fresh your media station list.

The Path is: Long press **MODE/MENU** → **< Clear My playlist >**, press **SELECT** to confirm.

- Prune Servers

1. Long press **MODE/MENU** → **< Prune servers >**, press **SELECT** to confirm.
2. Turn **SELECT** to 'Yes' while your radio asks you 'Prune shared media wake on LAN servers?', press **SELECT** to confirm.

- Now Playing Information

1. While a track is playing, the screen shows its track, artist and album if provided. There is also a progressing bar with figures for elapsed and total track time.
2. To view further information, press **INFO/POWER** repeatedly, screen will display information such as Artist, Album, Playback buffer indicating bar and Today's Date etc.

Chapter 3 DAB Mode

3.1 Getting Started

1. Press **MODE/MENU** repeatedly until **< DAB radio >** is showing up. For initial use, it will make a full scan and store stations list in memory,

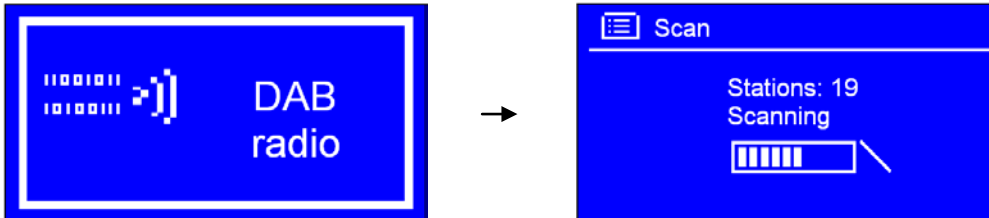

Note: or long press **MODE/MENU** to enter **< Main menu >**, and then turn **SELECT** to **< DAB >**, press **SELECT** to confirm.

2. Once the scanning is completed, the DAB/DAB+ stations will be displayed in alphanumeric order. The first station in the list will be selected.

Note: if no DAB/DAB+ signal is found in your area, it may be necessary to relocate your radio to a stronger signal area.

3.2 Shift to another DAB/DAB+ Station

1. While a DAB/DAB+ program is playing, you can move back to the previous screen at any time by pressing **BACK**, or pressing and hold **MODE/MENU** to go to 'station list'
2. While cursor point to '**Station list**', press **SELECT** to confirm.
3. Turn **SELECT** to cycle through stations list, and then press **SELECT** to confirm.

3.3 Update Station List

It's a good idea to carry out a 'scan' from time to time to keep your DAB/DAB+ station list up-to-date.

1. Long press **MODE/MENU** → turn **SELECT** to **< Scan >**, press **SELECT** to confirm.

3.4 Dynamic Label Segment (DLS)

1. This is scrolling text information supplied by the DAB/DAB+ station. It may comprise information on music title or detail of the program which is provided by the broadcaster.
2. To view further information, press **INFO/POWER** repeatedly while a DAB/DAB+ program is playing, screen will appear displaying information such as Artist, Album, Playback buffer indicating bar and Today's Date etc.

3.5 Prune Invalid

1. Long press **MODE/MENU** → turn **SELECT** to **< Prune invalid >**, press **SELECT** to confirm.
2. Turn **SELECT** to '**YES**', and press **SELECT** to confirm.

3.6 DRC (Dynamic Range Control) Value

You can set the level of the compression of stations to eliminate the differences in dynamic range or sound level between radio stations.

-  **Note:** a. Set DRC to **off** indicates no compression.
b. set DRC to **low** indicates little compression.
c. set DRC to **high** shows maximum compression.

1. Long press **MODE/MENU**→ turn **SELECT** to < **DRC** >, press **SELECT** to confirm.
2. Turn **SELECT** to your preferred option, press **SELECT** to confirm.

3.7 To change station order

1. The path is: Long press **MODE/MENU**→ < **Station order** >, press **SELECT** to confirm.

-  **Note:** There are 3 options: *Alphanumeric, Ensemble and Valid*. # shows before the default of your setting option to indicate current station order.

STATION ORDER	DESCRIPTION
Alphanumeric	Display all stations in alphanumeric order.
Ensemble	List the current broadcasting stations before inactive stations.
Valid	Remove inactive stations from the station list.

2. Turn **SELECT** to your selecting option, press **SELECT** to confirm.

Chapter 4 FM Mode

4.1 General Operation

1. Press **MODE/MENU** to shift to < **FM Radio** > from DAB mode. For initial use, it will start at the beginning of the FM frequency range (87.50MHz). Otherwise, the last listened FM station will be selected.

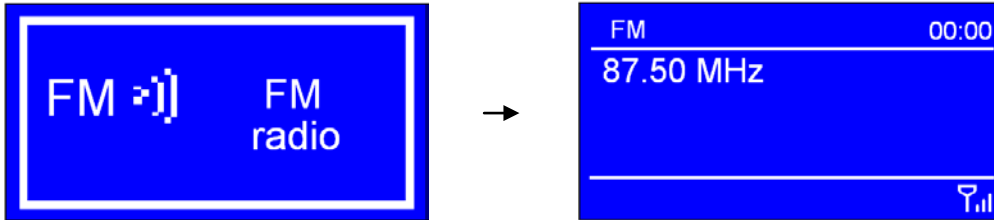

Note: or enter < **Main menu** > → turn **SELECT** to < **FM** >, press **SELECT** to confirm.

2. While frequency is showing up, press **SELECT** and then turn **SELECT** to manually adjust frequency 0.05MHz per step.
3. To auto-searching, Long press **SELECT** while frequency is showing up.

Note: a. To 'auto-searching' the next active station, repeat step 3.
b. The unit will display the frequency changing until it stops on the next station.

4.2 Scan Setting

By default, FM scans stop at any available station. This may result in a poor signal-to-noise ratio (hiss) from weak stations.

To change the scan settings to stop only at stations with good signal strength, long press **MODE/MENU** → < **Scan setting** > → **Strong stations only?** → **Yes**, press **SELECT** to confirm.

4.3 Audio Setting

By default, all stereo stations are reproduced in stereo. For weak stations, this may result in a poor signal-to-noise ratio (hiss).

To play weak stations in mono, long press **MODE/MENU** → < **Audio setting** > → **Listen in mono only?** → **Yes**, press **SELECT** to confirm.

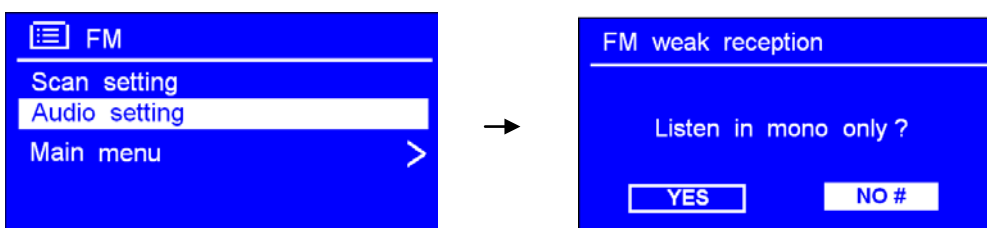

4.4 Station Presets (for Internet, DAB and FM Mode)

 **Note:** Your radio can store 10 Internet, 10 DAB/DAB+ and 10 FM stations preset. This order only limit to Internet, DAB and FM mode.

To store the current station:

1. Press and hold **PRESETS** until it shows : 'Save Preset' , and then turn **SELECT** to your selecting option 1-10.
2. Press **SELECT** to confirm, your radio would indicate '**Preset stored**', and then your radio will return to its normal working condition, and preset icon appeared on display.

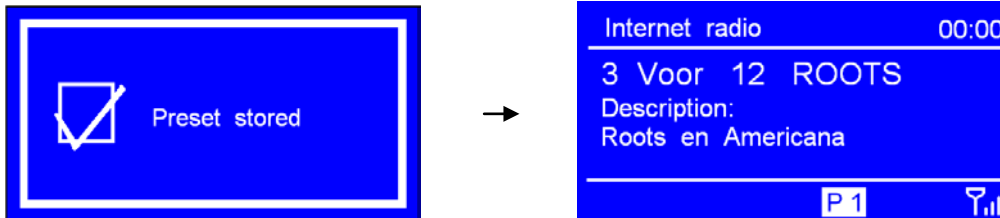

4.5 Access Preset Station (for Internet, DAB and FM Mode)

 **Note:** this order only limit to Internet, DAB and FM mode.

To select a stored station:

1. Press **MODE/MENU** to go to relative mode: Internet, DAB or FM mode.
2. Press **PRESETS**, it will show '**Recall Preset**', and then turn **SELECT** to your selecting one.
3. Press **SELECT** to confirm.

Chapter 5 AUX IN Mode

1. Press **MODE/MENU** repeatedly until < **Aux in** > is showing up.



Note: Or, enter '**MAIN MENU**', and then turn **SELECT** to < **Auxiliary Input** >, press **SELECT** to confirm.

2. Through a 3.5mm cable connection, a high quality digital audio source can be automatically output through the radio.

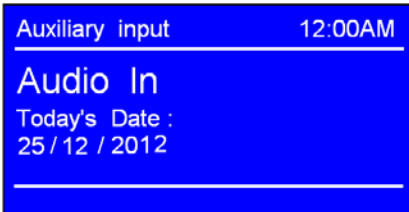

3. Connect one end of the audio cable to the headphone (or auxiliary out) socket of your source device, the other end connect to AUX IN socket on the rear of your radio.

The radio display will show:

4. To gain optimal volume levels, adjusting the output volume level on both the source device and the radio itself are recommended.

Note: **AUX IN** allows quick and easy connection the MP3 player or other external sound sources.

Chapter 6 General Settings

6.1 Sleep Function

1. It can be activated from < **Main menu** > → < **Sleep** >, press **SELECT** to confirm.

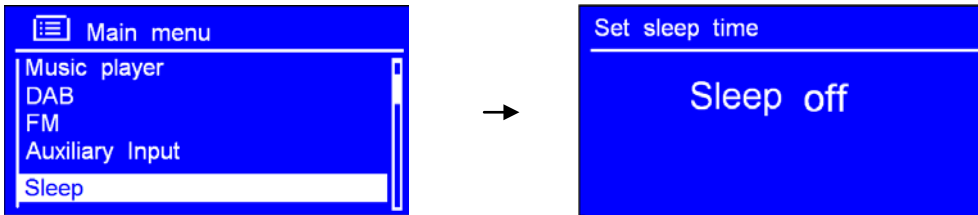

2. Turn **SELECT** to define the sleep period: off/15/30/45/60 minutes.
3. When your selecting period is appeared, simply stop turning, and it is done!

Note: At this step, sleep icon shows up, as well as shows how long it will be expired.

4. Radio will automatically put itself into standby mode after it has elapsed.
5. To continue enjoying your program, long press **INFO/POWER**.

6.2 Setting Clock

1. It can be activated from < **Main menu** > → < **Time/Date** >, press **SELECT** to confirm.

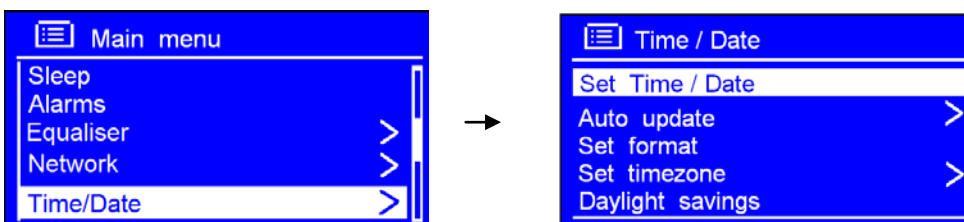

Note: here, turn the **SELECT knob**, a range of time settings is available, which include the functionality to set:

- <Set Time/date>: Manually set-up both Time and Date
- <Auto update>: 'Update from DAB', 'Update from Network' and 'No update'
- <Set format>: 'Set 24 hour' and 'Set 12 hour'
- <Set timezone>: turn **SELECT** to your location timezone, press this knob to confirm
- <Daylight savings>: turn **SELECT** to 'ON', and then press this knob to confirm, it is done!

6.3 Browse Station Information

It is possible to view the information that is displayed on the second line of the display when you are listening a radio program.

To browse more information, you can achieved by pressing **INFO/POWER** repeatedly.

Note: for this function, 'AUX in' mode is out of service.

6.4 Setting Alarm

 **Note:** Setting Alarm, make sure setting time at first.

1. Long press **MODE/MENU** → < Main menu > → < Alarms >, press **SELECT** → turn **SELECT** to your selecting one, press this knob to confirm.

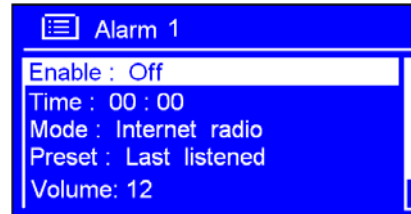
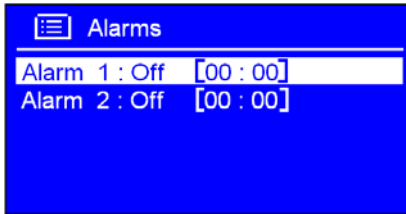

2. Configure the following parameters:

- **Enable:** Off, Daily, Once, Weekends or Weekdays
- **Time:** 00:00
- **Mode:** Buzzer, Internet radio, DAB, or FM
- **Preset:** this option depends on which alarm mode you have set, this option won't be available unless you choose Internet radio, DAB, FM as alarm sound mode
- **Volume:** Muted-32
- **Save:** finally, turn **SELECT** to this option, and press this knob to make sure alarm saved

The screen shows active alarms with an icon at the bottom left.

To check alarms status, long press **INFO/POWER** to enter standby mode.

- **Turn Alarm off**

When alarm is coming, long press **INFO/POWER** to turn it off

- **Play Snooze Function**

Press **SELECT** to postpone it for 5 minutes, repeatedly press to prolong snooze to other user-defined snooze time.

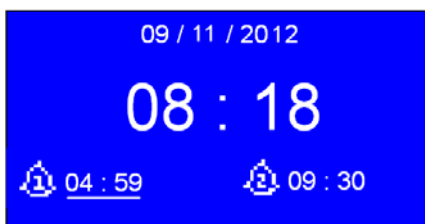

-  **Note:** a. While in SNOOZE function, the relative alarm shall be twinkling, and shows how long it will be elapsed, during this time, you can also long press **INFO/POWER** to put the alarm off and long press **INFO/POWER** again to have your radio play.
b. After reach SNOOZE time, it will sound again.

- **To cancel Alarm**

Refer to above steps1-2, set '**Alarm Enable status**' to '**Off**', and then turn **SELECT** to '**Save**', press **SELECT** to confirm, your radio will save your settings and show '**Alarm saved**'.

6.5 Equaliser

1. It can be activated by long pressing **MODE/MENU** → < **Main menu** > → < **Equaliser** >, press **SELECT** to confirm.
2. It will show 'My EQ profile setup'.
 - a. Press **SELECT** to confirm **Bass**, turn **SELECT** to adjust, and then press **SELECT** to confirm.
 - b. Setting **Treble** accordingly.
 - c. Finally turn **SELECT** to '**Loudness**', press **SELECT** to shift it from off to on, or vice versa, shift from on to off.
3. Or, you can simply press '+ **TRE** -' or '+ **BASS** -' via remote control to conduct this order.

6.6 Language

1. It can be activated by long pressing **MODE/MENU** → < **Main menu** > → < **Language** >, press **SELECT** to confirm.
2. Turn **SELECT** to your selecting one, and then press **SELECT** to confirm, it is done!

6.7 Factory Reset

A factory reset resets all user settings to default values, so time/date, network configuration and presets are lost. However, the radio's current software version is maintained, as is registration with the Internet radio portal. Internet radio favourites are kept unless you re-register your radio with another account on the portal website.

1. It can be achieved by long pressing **MODE/MENU** → < **Main menu** > → < **Factory Reset** > →
Proceed? YES or NO.
2. Press **SELECT** to confirm 'YES'.

6.8 Enter Setup Wizard

When this unit is started for the first time, it runs through a setup wizard to configure settings for date/time and network. Once this has finished, the system is ready to use.

1. To run the setup wizard again, long pressing **MODE/MENU** → **Main menu** → **Setup wizard** → **Yes**.
2. Press **SELECT** to confirm, then step by step to set it.

6.9 SW Version and Radio ID (or System Info)

This information may be requested when dealing with technical support issues, system info includes SW version, radio ID and Friendly name (radio name).

It can be activated from < **Main menu** > → < **Info** >, press **SELECT** to confirm.

6.10 Network Setup

 **Note:** Users experiencing network issue may find these options useful for diagnosing and fixing network problems.

1. The path is: Long press **MODE/MENU** → < **Main menu** > → < **Network** >.
2. Turn **SELECT** to your selecting network setting option:
 - ☒ Want to access to another Router? ----- **Network wizard**
 - ☒ Want to set up a WPS encrypted network? -----**PBC Wlan setup**
 - ☒ Want to get MAC address, Wlan region, IP address etc? ----- **View settings.**
 - ☒ Want to set it to another region? ----- **Wlan region**
 - ☒ Want to shift your radio connection between wired network (LAN) and wireless? ----- **Manual settings**
 - ☒ Want to see the list of registered networks or delete some of unwanted networks? ----- **Network profile**
3. Press **SELECT** to confirm to enter setting.

6.11 Software Update

From time to time, your radio may make software upgrades due to bug fixes and/or additional features.

If your radio detects that newer software available, it asks if you want to go ahead with an update. If you agree, the new software is then downloaded and installed.

After a software upgrade, all user settings are maintained.

C A U T I O N

Before starting a software upgrade, ensure that your radio is plugged into a stable mains power connection. Disconnecting power during a software update may permanently damage the unit.

1. It can be activated by long pressing **MODE/MENU** → **Main menu** → **Software update** → **Auto-check setting**, press **SELECT** to confirm. '**Check now**' is also a convenient option for your radio to detect new software

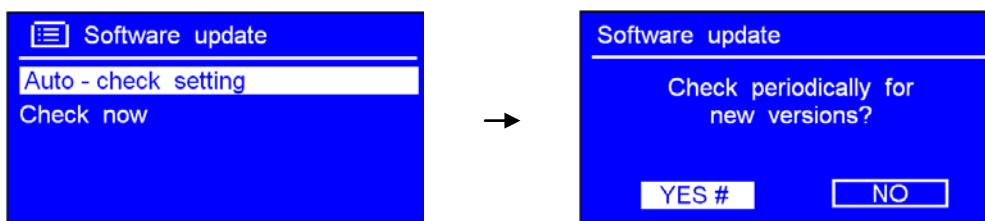

2. Turn **SELECT** to < **YES** >, press this knob to confirm.

6.12 Backlight

 **Note:** High brightness level can get you pretty easy to view the station information. Set to Low is for energy saving purpose.

- **For Power on condition:**

It can be activated from < **Main menu** > → < **Backlight** > → **Power on Level** → **Low/Medium/High**. (Setting to high level is recommended!)

- **For Standby condition:**

Its access path is similar to 'power on condition', however, set to 'Low or Medium' is recommended.

Chapter 7 Specification

Items	Description
Specifications:	Internet, DAB/DAB+ and FM radio
Frequency Ranges:	FM: 87.5-108MHz DAB/DAB+: 174.928 – 239.200MHz
LCD Display:	High resolution display
Power Requirements:	100-240 Vac, 50-60 Hz
Dimension:	157 x 49 x 86mm



This symbol on the product or in the instructions means that your electrical and electronic equipment should be disposed at the end of its life separately from your household waste. There are separate collection systems for recycling in the EU.

For more information, please contact the local authority or your retailer where you purchased the product.

Chapter 8 Troubleshooting

If you experience any trouble with your wireless Internet Radio, then you may find it useful to visit the help section on our webpage: <http://www.wifiRadio-frontier.com>

If you have trouble connecting the Radio to your wireless network, these steps may help to resolve the problem:

1. Confirm that a Wi-Fi connected PC can access the Internet (i.e. can browse the web) using the same network.
2. Check that a DHCP server is available, or that you have configured a static IP address on the Radio. You can configure a static IP address on the Radio using the menu item 'System settings → Network → Manual settings → Wireless', and then select 'DHCP disable'.
3. Check your access point does not restrict connections to particular MAC addresses. You can view the Radio's MAC address using the menu item 'System settings → Network → View settings → MAC address'.
4. If you have an encrypted network, check that you have entered the correct key or password into the Radio. Remember that text-format keys are case sensitive. If, when attempting to connect to an encrypted network, your Radio displays: 'Wireless error' followed by a 5-digit number, then please ensure that you enter the correct passphrase for the network. If the problem persists, then you may need to consult your network configuration.
5. If your Radio can connect to the network successfully, but is unable to play particular stations, it may be due to one of the following causes:
 - a. The station is not broadcasting at this time of the day (remember it may be located in a different time zone).
 - b. The station has reached the maximum allowed number of simultaneous listeners.
 - c. The station is not broadcasting anymore.
 - d. The link on the Radio is out of date.
 - e. The Internet connection between the server (often located in a different country) and yours is slow.Try using a PC to play back the stream via the broadcaster's web site.
6. If you can play back the station with a PC, use the form at <http://www.wifiRadio-frontier.com> to notify us so that we can change the station data that is used by the Radio.

ELKO AS, Eyvind Lyches vei 10, 1338 Sandvika, NORWAY. Phone 004767215459. www.elko.no.

ELKO AB, Hammarby Kaj 14, 121 17 Johanneshov. Phone 0046 8 449 27 27. www.elko.se